

Resolver 40VRX

Minebea

Specifications

Number of multiple	2X-6X
Input Voltage [AC Vrms]	7
Input Frequency [KHz]	10
Transformation Ratio	0.286
Maximum Rotation Speed [r/min]	12000
Operation Temperature Range	-40 - +125
Stator Outer Diameter [mm]	101
Rotor Inner Diameter [mm]	45
Stack Thickness [mm]	4



Dimensions

[mm]

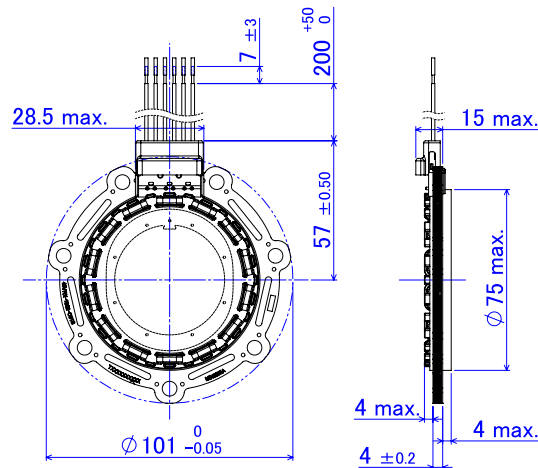

[mm]

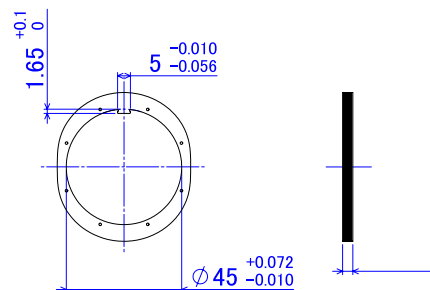

Rotor 2X