

## Characteristic

- DC 24V ~ DC 105V  
High voltage and low voltage applicable
- High voltage version is under development
- Driver :  
Driver circuit external (Standard)  
Driver circuit internal (DC24V、7W)
- Output power : 7W ~



■ 3 Phase 4 holes inner rotor type DC Brushless Motor

## Major Characteristic Parameters (at 24V)

Item	Specification
No load speed	5200 [min <sup>-1</sup> ]
Starting torque	120 [mN·m]
Starting current	2500 [mA]
Maximal efficiency	74.5 [%]
Speed at maximal efficiency	4300 [min <sup>-1</sup> ]
Life at 20°C	5000 [hour]

※ Adjustable by winding

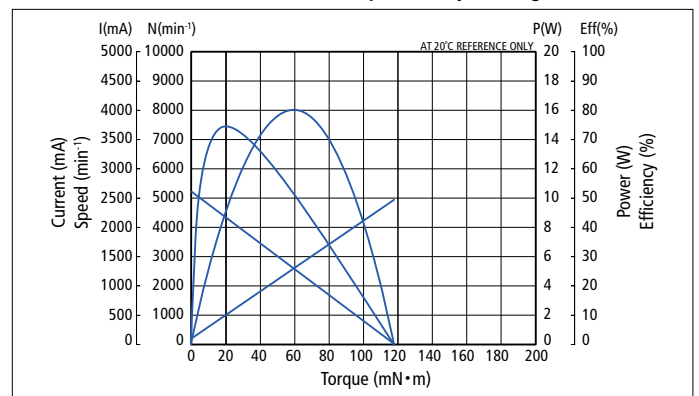

## Outside Dimension (Reference)

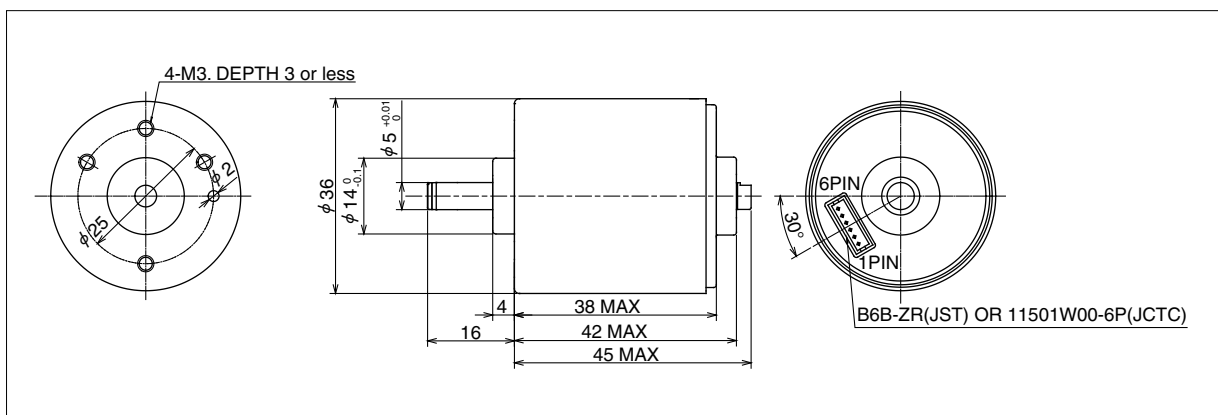

Please contact our sales for detail specification & order lot QTY. (All custom product by customer's requirement)