

BLDC 65S35A

41.P.060

Brushless 3 – Phase DC Motor



Rated Voltage	No Load Speed	Rated Speed	Cont. Power	Rated Torque	Current at rated Speed	Efficiency at Duty Point
---------------	---------------	-------------	-------------	--------------	------------------------	--------------------------

[V]	[rpm]	[rpm]	[W]	[mNm]	[A]	[%]
-------	---------	---------	-------	---------	-------	-------

24	3.630	3.460	138	380	6,0	87
----	-------	-------	-----	-----	-----	----

Motor Code: 121588800013

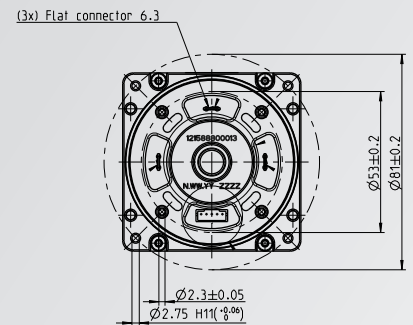
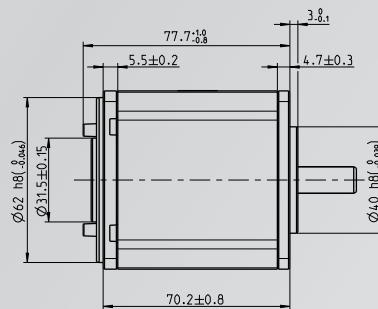
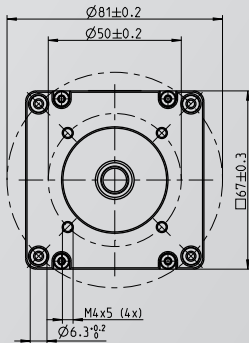

General informations

- **Class of protection:** IP20
- **Mounting position:** free
- **Duty cycle:** up to 100 %
- **Bearing system:** Ball Bearings
- **Torque Constant:** 60,4 mNm/A
- **Weight:** 1,19 kg
- **Rotor Inertia:** 301 gcm²
- **Oper. Temp. Range:** 0 °C to +45 °C
- **Max. Temp. Rise:** 70 K
- **Direction of Rotation:** CW / CCW
- **Class of Insulation:** H
- **Shaft Material:** Steel, not hardened
- **Number of Poles:** 8

Options

- **Integrated Drive Electro.:** Yes
- **Planetary Gearbox:** Yes
- **Sensorless Operation:** No
- **Shaft hardened (Surface):** Yes

Features

- High power-to-volume ratio
- High efficiency at duty point
- Extremely reliable

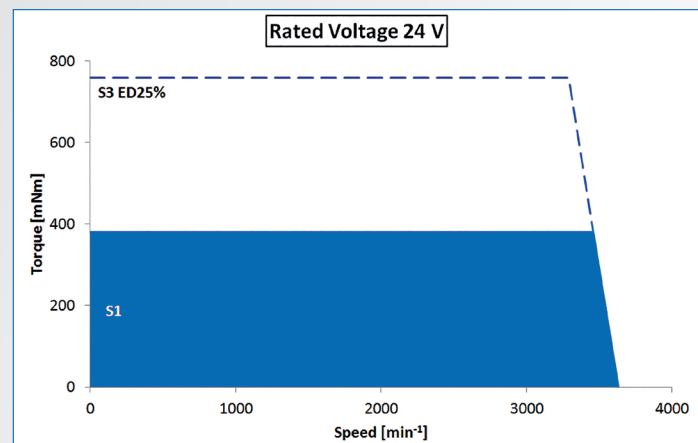

NMB Technologies Corporation
 A MinebeaMitsumi Group Company
 39830 Grand River Avenue
 Novi, MI 48375
 Tel: 248-919-2250
 eMail: info@nmbtc.com
 nmbtc.com

MinebeaMitsumi
 Passion to Create Value through Difference