

General Specifications

Motor Type: DC Brushless Motor

Motor Protection: Auto Restart/Polarity Protection

Motor withstands reverse connection for positive and negative leads.

Insulation Resistance:

10M Ω or over with a DC500V Megger

Dielectric Withstand Voltage:

AC 700V 1s or 500V 1min

Allowable Ambient Temperature Range:

-10°C ~ +70°C (Operating)

-40°C ~ +70°C (Storage)

(non-condensing environment)

Characteristics Curves

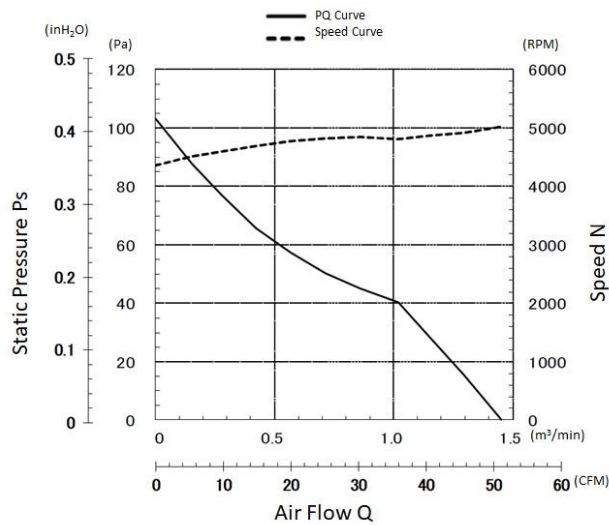

PWM Benefits & Applications

PWM Benefits

- Increased Life Expectancy
- Energy Saving
- Lower Vibration
- Lower Noise
- Current Spike Prevention

PWM Applications

- Routers
- Switches
- Storage
- Data Centers
- Optical Repeaters
- Broadcast Equipment
- Inverters
- UPS
- Battery Chargers
- Fuel Cells
- Industrial Power Supplies
- Welders
- Plasma Cutters
- Instrumentation
- Test Equipment
- Enclosures and more

- Customized fan performances at multiple operating points.
- Peak efficiency resulting in lower total ownership costs.
- Cost effective and better reliability.

Life Expectancy L10

40°C 70,000 Hours

Specifications

MODEL	Rated Voltage	Operating Voltage	Current		Input Power		Speed	Max. Air Flow		Max. Static Pressure		Noise	Mass
	(V)	(V)	Avg	Max	Avg	Max		(CFM)	(m³/min)	(inH ₂ O)	(Pa)		
	(V)	(V)	(A) ^{*1}	(A) ^{*1}	(W) ^{*1}	(W) ^{*1}	(min ⁻¹) ^{*1}	(CFM)	(m³/min)	(inH ₂ O)	(Pa)	(dB) ^{*1}	(g)
08025DA-12N-EU-02	12	7.0 ~13.2	0.22	0.40	2.64	4.80	5000	51.2	1.45	0.42	105	45.0	120

*1: Values in Free Air

PWM Specifications

PWM CONTROL CONNECTION

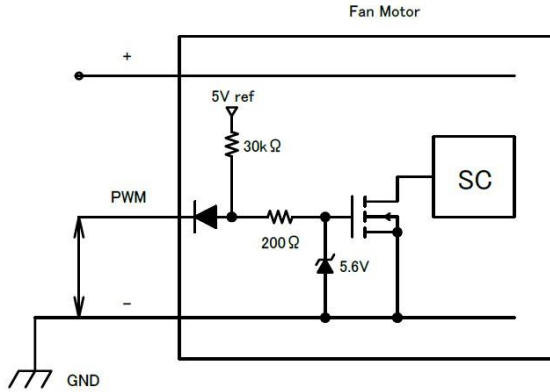

1. PWM Control

- V_{st} = Low Level (0V~0.4V) → Stop (On Duty 0%)
- V_{st} = High Level (4.0V~5.0V) → Full Speed (On Duty 100%)
- V_{st} = Open → Full Speed

2. PWM Duty & PWM Input Pulse

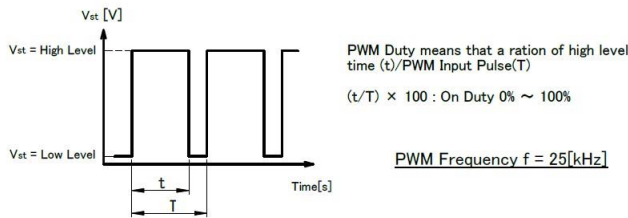

TACHO Specifications

TACHO SIGNAL

1. OUTPUT CIRCUIT : OPEN COLLECTOR
2. SPECIFICATION

Ta=25°C

Absolute Maximum Ratings at Ta=25°C

V_{CE} max : +15V

I_c max : 5mA [V_{CE(sat)}max = 1.5V]

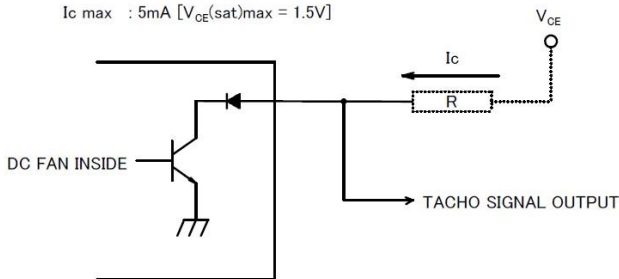

TACHO SIGNAL CIRCUIT

PWM Characteristics Curve

Reference PWM Duty VS Speed

Conditions: at rating Voltage, V_{st}=5.0V, f=25kHz, Ta=25°C

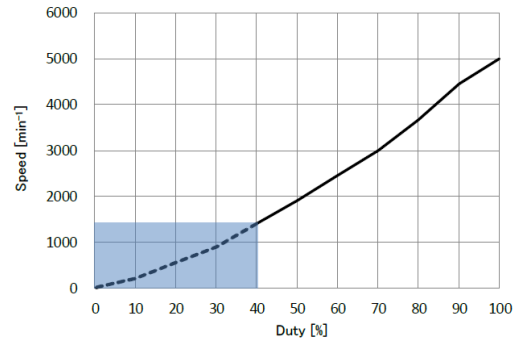

3. The condition for PWM control are as follows.

•When you use this under PWM control, always be sure the motor's operation under practical mounting state.
Fan motor may not start up caused by PWM control at very low speed condition.

•To run at Rating Voltage.

•Please use the start with Duty 40% or more at 25kHz.
[At rated voltage input, Ambient temperature 25°C]

3. OUTPUT WAVEFORM : AT RATED VOLTAGE

OUTPUT SIGNAL VOLTAGE

3-1 Case-1

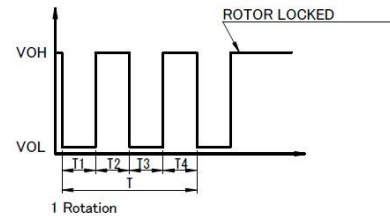

3-2 Case-2

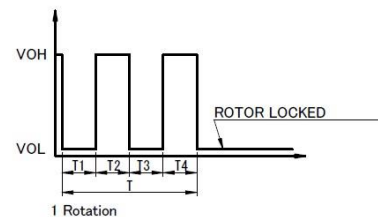

- 1) When the rotor is locked at VOH position of signal, signal keeps VOH position.
- 2) When the rotor is locked at VOL position of signal, signal keeps VOL position.
- 3) T=T1+T2+T3+T4=60/m=1 rotation

m : min⁻¹

Tach Duty Cycle=50%±10%

Panel Cut-Outs

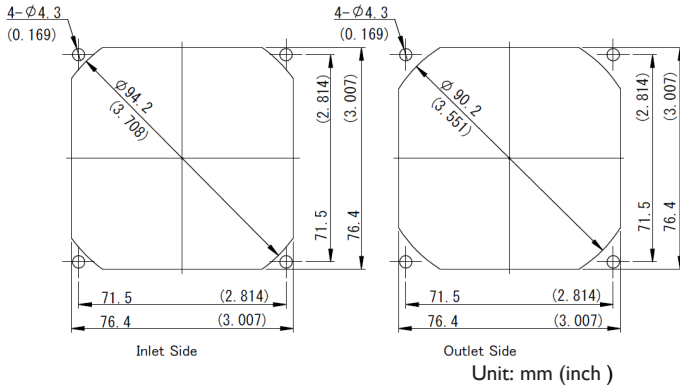

Materials

- Casing : Plastic (Black UL94V-0)
- Impeller : Plastic (Black UL94V-0)
- Bearing : Ball Bearing
- Lead Wire : UL10368 AWG26 or UL3443 AWG26
- (+) : Red (-) : Black
- PWM : Brown Tach : White

Outline

Name Plate

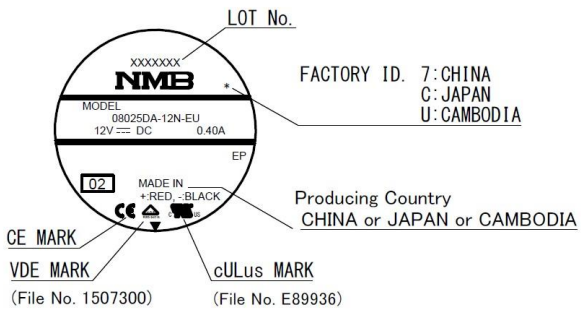

FLANGE TYPE

